



Decontactor DX9 125A

Protection mode:

Type of protection: II 2GD Ex de IIC
Td A21
Classe of temperature: T6-T5
Protection degree: IP65
Certificate: LCIE Ex 07.001 / LCIE 04 ATEX

Operations for connections :



Technical data:

- Rated current (with wiring according to standard) 125 A
- IP protection lid close IP65
- IP protection connected plug IP65
- Resistance to shocks IK 10
- Umax AC 750 V
- Ambient Temperature -25 °C à +60 °C
- Flexible wiring (min - max) 50 - 70 mm²
- Stranded wiring (min - max) 50 - 70 mm²

Other wiring on request :

- Keying positions 12
- Protection mode : de
- Zones : 1-2-21-22

Locking with allen key

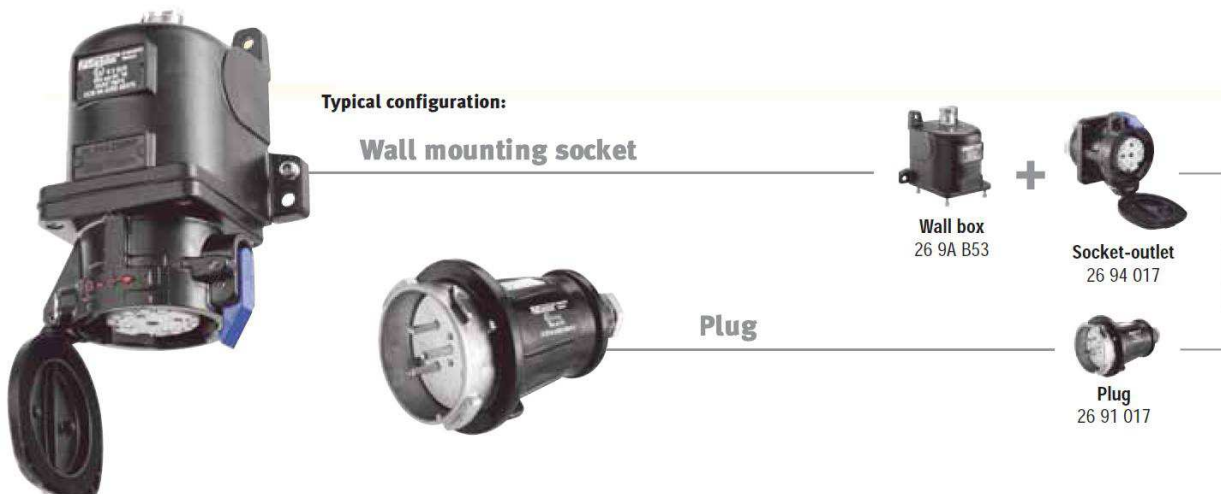



Decontactor DX9 125A

Socket-outlet (Female)



Voltage 50 Hz	Polarity	Part no.
380 - 440V	3P+E	26 94 013
380 - 440V	3P+N+E	26 94 017

Inlet (male)



Voltage 50 Hz	Polarity	Part no.
380 - 440V	3P+E	26 98 013
380 - 440V	3P+N+E	26 98 017

Boxes Ex cable gland included



PE Entry	Part no.	
M32	26 9A B53 32M	12 – 21 mm
M40	26 9A B53	16 – 27 mm
M50	26 9A B53 50M	23 – 35 mm
M63	26 9A B53 63M	36 – 48 mm

Plug (male) Ex cable gland included



Voltage 50 Hz	Polarity	Part no.	
380 - 440V	3P+E	26 91 013	16 – 27 mm
380 - 440V	3P+N+E	26 91 017	16 – 27 mm

Handle Ex cable gland included



PE Entry	Part no.	
M32	26 9A 953 32M	12 – 21 mm
M40	26 9A 963	16 – 27 mm
M50	26 9A 953 50M	23 – 35 mm
M63	26 9A 953 63M	36 – 48 mm

Boxes Ex cable gland included



PE Entry	Part no.	
M32	26 9A B53 32M	12 – 21 mm
M40	26 9A B53	16 – 27 mm
M50	26 9A B53 50M	23 – 35 mm
M63	26 9A B53 63M	36 – 48 mm



Decontactor DX9 125A

Socle de Tableau

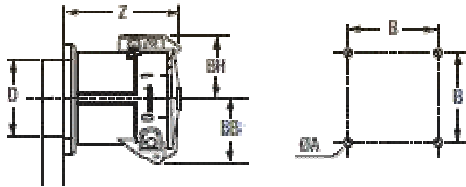

	Z	D	H	BH	BB	B	ØA
DX1 / DX3	95	104	55	66	85	92	6,7
DX6 / DX9 / DX2	173	148	90	92	110	121	9

Socle de Tableau

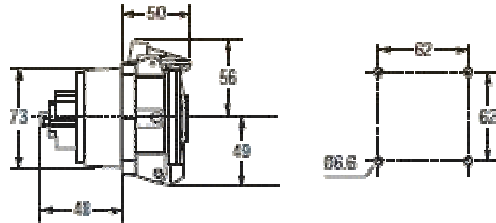

PX

Socle Murale

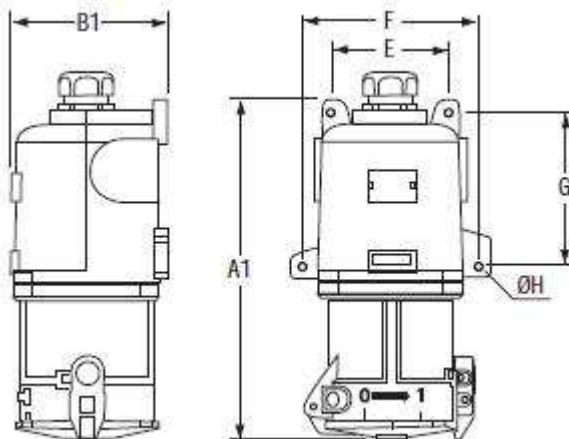

	A1	B1	E	F	G	ØH
DX1 / DX3	240	125	90	145	119	9
DX6 / DX9 / DX2	378	175	130	195	174	9

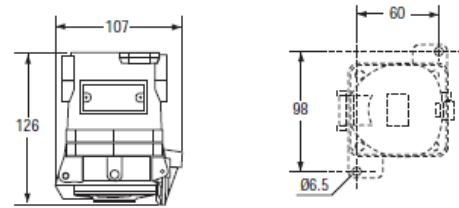

PX

Fiche enclenchée (A1)/ déclenchée (A0) dans un socle mural

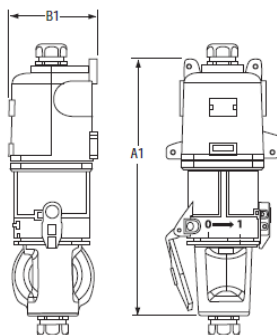

	A1	B1	E	F	G	ØH
DX1 / DX3	240	125	90	145	119	9
DX6 / DX9 / DX2	378	175	130	195	174	9

Fiche enclenchée (A1)/ déclenchée (A0) dans un socle mural

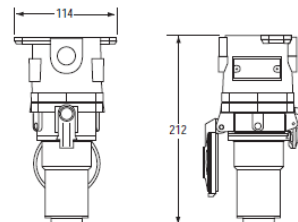

PX