



PB2 Pushbuttons series

Protection mode:

Type of protection:

II 2G Ex d IIC (ou IIB, IIB+H2) T6...T4 Gb
II 2D Ex tb IIIC T85°C...T135°C Db IP66

Class of temperature: T6...T4
Protection degree: IP66
Température ambiante : -20/+40°C
Zones : 1-21-2-22



Description:

PB series pushbuttons, made of aluminium light alloy, with external bolts in stainless steel and RAL 7000 epoxy vinyl coating, are available in accord to all different requirements because of their big choice of control and signalling units.

Technicals data:

- Nominal current : 10 A
- Nominal Isolation Voltage : 660 V
- Nominal pulse Voltage : 6 kV
- Short circuit protection $U_e < 500$ Vac : Cartridge Fuse 10 A
- Terminals ID : according to IEC/EN 60947-1
- Screw type joining terminals with captive clamp
- Max wires section: : 2x2,5 mm²
- Self cleaning contacts : EN01(NC) EN10(NA)
- Working cycles: :1800 operations / hr (max)

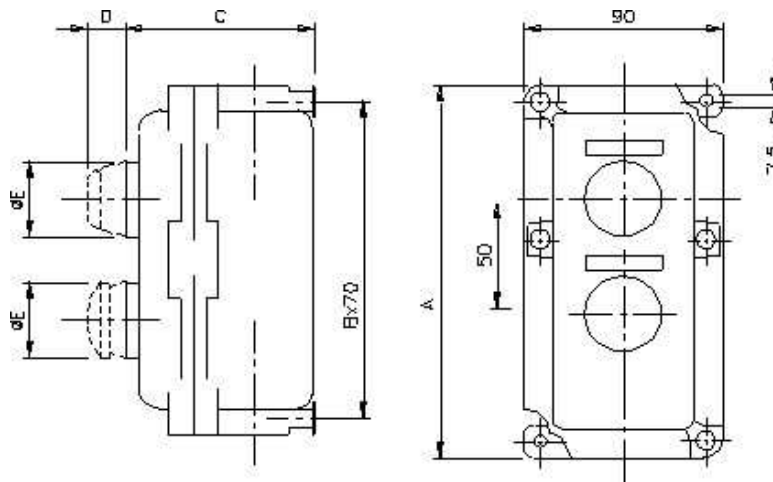



PB2 Pushbuttons series

Type	Element(s)	Cables entries		B	c	F	Weight (g)
		ØA	n				
PB2	2	3/4 NPT	2	156	87	136	685

Element	Symbol	Dimensions		Contacts	Weight (g)
		D	ØE		
START pushbutton	1	16	32	1NO	90
STOP pushbutton	0	16	32	1NC	90
Lighting START pushbutton	1R-1B-1V-1G-1A	16	32	1NO	130
Lighting STOP pushbutton	0R-0B-0V-0G-0A	16	32	1NC	130
Mushroom type push button with spring return	5	30	50		100
Key switch 1-2 poles (pos. 0-1)	7/1-7/2	60	30		400
Two position key changeover switch 1-2 poles (pos. 1-2)	7/1D - 7/2D	60	30		400
Three position key changeover switch 1-2 poles (pos. 1-0-2)	7/1C - 7/2C	60	30		400
Triangular Key switch 1-2 poles (pos. 0-1)	9/1 - 9/2	50	41		370
Two position triangular key changeover switch 1-2 poles (pos. 1-2)	9/1D - 9/2D	50	41		370
Three position triangular key changeover switch 1-2 poles (pos. 1-0-2)	9/1C - 9/2C	50	41		370
Mushroom type push button with locking	8	30	50	1NO+1NC	100
Mushroom type push button with rotary locking	8R	58	33	1NO+1NC	180
Mushroom type push button with locking and keylock	8K	58	33	1NO+1NC	180
Pilot light	R-B-V-G-A	16	32		130
Two way changeover switch 1-2 poles (pos. 1-2)	i1-i2	22	32		300
Three way changeover switch 1-2 poles (pos. 1-0-2)	D1-D2	22	32		300
Potentiometer control (single turn) (*)	C1-C2	22	32		300
Potentiometer	P	16	15		